

UB-5838C / UB-5338C Specifications

General	
Power Supply	AC 220 - 240 V, 50/60 Hz
Power Consumption	Less than 0.4 A / Less than 0.15 A (Operational / Standby)
Display	1.8" Colour LCD
External Dimensions*1 (H x W x D)	
UB-5838C (with stand)	1,830 mm x 1,998 mm x 1,207 mm (72.1 in. x 78.6 in. x 47.5 in.)
(without stand)	1,125 mm x 1,998 mm x 224 mm (44.3 in. x 78.6 in. x 8.8 in.)
UB-5338C (with stand)	1,830 mm x 1,636 mm x 1,207 mm (72.1 in. x 64.4 in. x 47.5 in.)
(without stand)	1,125 mm x 1,636 mm x 224 mm (44.3 in. x 64.4 in. x 8.8 in.)
Weight*1	
UB-5838C (with stand)	38 kg (84 lbs.)
(without stand)	28 kg (62 lbs.)
UB-5338C (with stand)	36 kg (80 lbs.)
(without stand)	26 kg (58 lbs.)
Ambient Operating Conditions	
Temperature:	10 °C to 35 °C (50 °F to 95 °F)
Humidity:	30 % to 80 % RH
Input Block	
Panel Dimensions (H x W)*1	
UB-5838C	838 mm x 1,740 mm (33.0 in. x 68.5 in.)
UB-5338C	838 mm x 1,378 mm (33.0 in. x 54.2 in.)
Panel Surface	
2 (endless scroll type)	
Scanning Area (H x W)	
UB-5838C	790 mm x 1,722 mm (31.1 in. x 67.7 in.)
UB-5338C	790 mm x 1,360 mm (31.1 in. x 53.5 in.)
Scanning System	
Contact Image Sensors	
Scanning Modes	
Colour / Black and White	
Scanning Size	
UB-5838C	Standard-size / Full-size
UB-5338C	Standard-size
Scanning Resolution (H x W)	
UB-5838C	Standard-size : 1.7 dot/mm x 1.7 dot/mm (44 dpi X 44 dpi) Full-size : 2.4 dot/mm x 1.7 dot/mm (61 dpi X 44 dpi)
UB-5338C	Standard-size : 2.2 dot/mm x 2.2 dot/mm (56 dpi X 56 dpi)
Scanning Time (Until the scanning is finished)	
Colour : 30 seconds Black and White : 20 seconds	
Memory Output	
Supported Memory Types*2	SD Memory Card, USB flash memory (Not included)
Support Format	SD Memory Card: FAT16 format, Maximum capacity 2 GB USB flash memory: FAT (FAT16) / FAT32 format, Maximum capacity 32 GB
USB Flash Memory Interface	USB 2.0 (Full Speed, USB Master, A-Type Connector)
SD Specification	Version 1.10 *SDHC Memory Card and SD I/O standard are not supported.
Store File Format	Colour Scanning: PDF or JPEG (JPEG Compression) Black and White Scanning: PDF or JPEG (JPEG Compression)

Printer Output	
Interface	USB 2.0 (Full Speed, USB Master, A-Type Connector)
Support Protocol	PCL 3 GUI (Most HP Colour Ink-Jet Printers)*2
Supported Printers	Refer to the Internet home page*2
Print Resolution	300 dpi x 300 dpi
Continuous Printing	1 to 9 sheets
Print Size	
UB-5838C	A4 Size
UB-5338C	A4 Size
PC Interface	
Interface	USB 2.0 (Full Speed, USB Slave, B-Type Connector)
Operating System	Windows Vista®, Windows® XP (SP2 or higher) Windows® 2000 (SP4 or higher)
Included Accessories & Consumables	
Clock Battery (CR2032), USB cable (2.4 m / 7 ft.), Wall-Mounting Kit Markers (1 black, 1 red and 1 blue), 1 Eraser	
Optional Consumables	
Markers and Eraser Set	KX-B035 (1 black, 1 red, 1 blue markers and 1 eraser)
Eraser	KX-B042 (set of 6 erasers)
Markers	KX-B031 (set of 10 black markers) KX-B032 (set of 10 red markers) KX-B033 (set of 10 blue markers)
Stand	UE-608035

*1 Dimensions and weights are approximate.

*2 For information regarding available USB flash memory devices, SD Memory Cards, and printers, refer to the following site: http://panasonic.net/pcc/support/eboard/ub-5838c_info.htm

Microsoft®, Windows®, Windows Vista® and the Windows logo are either registered trademarks or trademarks of Microsoft Corporation in the United States and/or other countries.

SD Logo is a trademark.

All other brand or product names are the property of their respective holders.

Design and specifications are subject to change without notice.

This product is designed to reduce hazardous chemical substances.

Panasonic

ideas for life



Options / Consumables

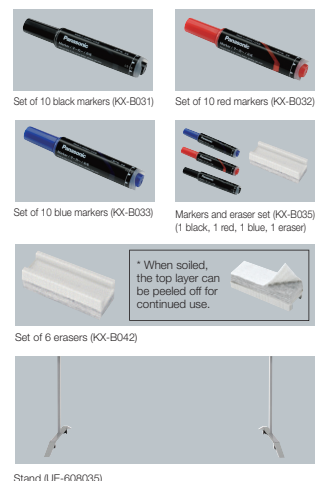

Dimensions

(Including optional stand)

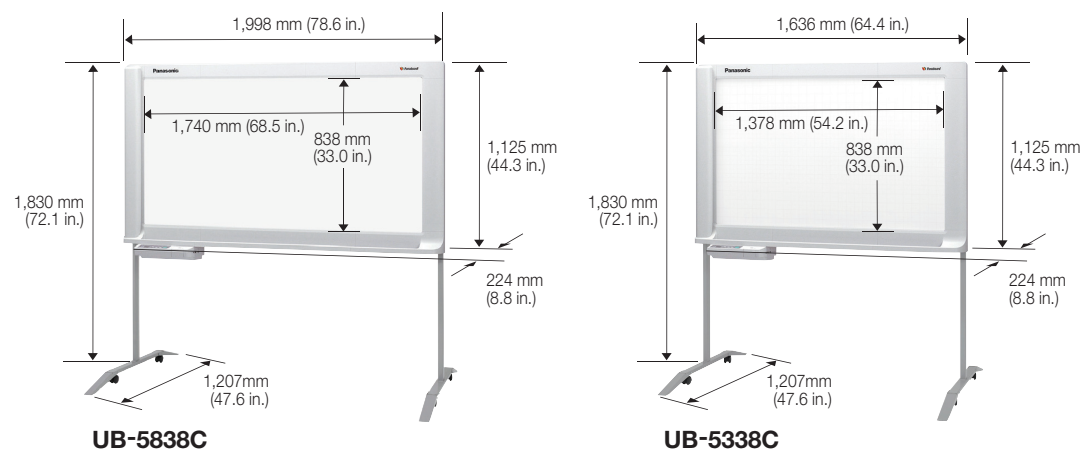

Colour Electronic Whiteboard

UB-5838C
UB-5338C



- Colour Scanning System
- SD Memory Card / USB Flash Memory Storage
- Colour Output with Recommended Colour Printer
- Easy-to-Read 1.8" Colour LCD
- Clear Marker Reproduction Technology
- Password Lock for Secure Operations

Panasonic

MG-C512EE 0908 Printed in Japan

Panaboard **SD**

View, Save and Share -- All in Colour.

This advanced colour Panaboard supports a variety of business situations with a wide range of functions. You can save the information written on the board onto a PC, an SD Memory Card, or USB flash memory, and distribute it as electronic data to your colleagues from a PC, all in colour. Operation is done using easy-to-understand icons. Panaboard gives you maximum power in presentations and conferences.



Easy visual confirmation Easy-to-Read 1.8" Colour LCD

Because it is equipped with a colour LCD that lets you confirm scanned data on the spot, its ecological design makes printouts no longer necessary. And because it displays the operating status with easy-to-follow icons, it is easy for anyone to operate.



Accurate scanning of even faded text Clear Marker Reproduction Technology

The faded marker text that was so difficult to scan can now be accurately scanned to produce easy-to-read conference notes.

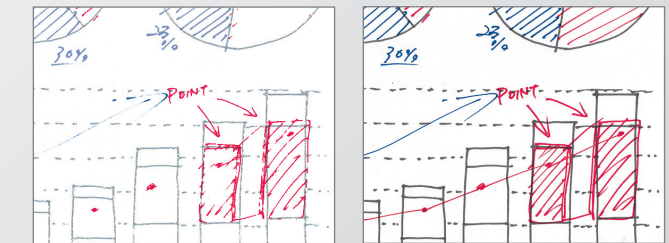

Conventional saved images Images saved by the UB-5838C / UB-5338C

Flexible installation Thin and Lightweight

This thin, lightweight board is ideal for wall mounting. Rear panel protrusions have been reduced to enable neater, more attractive mounting. The design is a great match for today's modern offices and conference rooms.

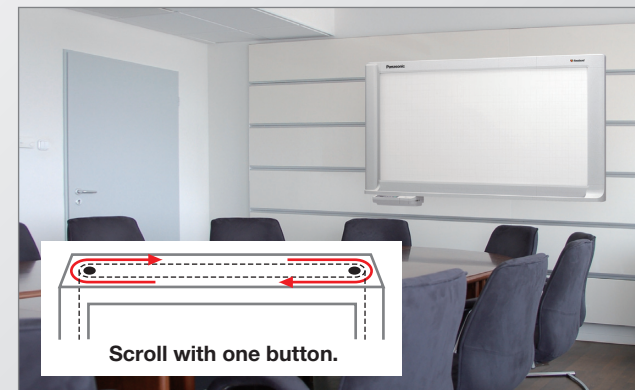

Helps prevent data leaks Password Lock for Operation

After turning on the power and setting a four-letter password, data cannot be saved until the password is input.

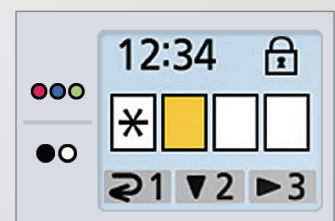

Operation Password function

By turning on the Screen Erase Announce function, an icon appears on the LCD when scanning is finished as a reminder that the board has not been erased.

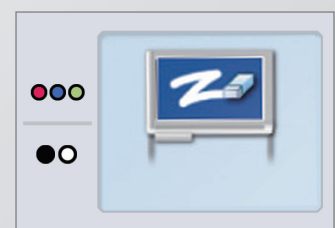

Screen Erase Announce function

Paperless, Data-Based Solutions

Save directly to memory PC-Free Data Storage Solution

Scanned data can be saved in PDF or JPEG formats on an SD Memory Card or USB flash memory, then transferred to your PC. Now you can easily edit it using the bundled Panasonic Document Management System software.



Save directly to a PC Direct PC Connectivity Solution

Simply connect the board to a PC with the USB cable to save the board content without having to install any special software. The board imitates USB flash memory, so no additional software is needed to store the scanned images.

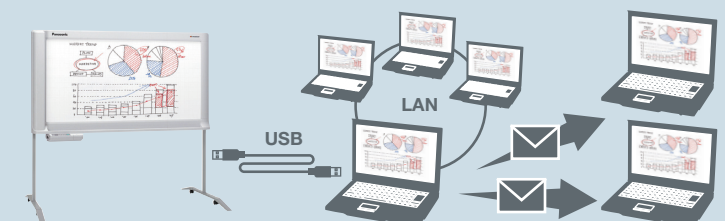

Versatile Colour Printing Solutions

Printing without a PC PC-Free Printing Solution

You don't need a PC to print a copy of the material written on the board. If your printer is equipped with an SD Card slot or USB flash memory slot, you can print data without using a PC. Just plug the storage memory device into the printer and press the Print button.



On-the-spot printing Direct Colour Printing Solution

The UB-5838C / UB-5338C come standard with a USB printer port. You can connect a printer* directly to the board using a USB printer cable and print data in vivid colour.

* For information regarding available printers, refer to the following site http://panasonic.net/pcc/support/eboard/ub-5838c_info.htm

